



# SNYDER



**Equipment, Inc.**

*Storing, Rolling, Lifting since 1947*

PRODUCT INFORMATION

# MIDWEST FOLDING PRODUCTS TABLES AND CHAIRS

2946 Larimer St. Denver, CO 80205  
303-295-1100 / 800-373-7693  
FAX 303-295-2464  
Email [info@snyderequipment.com](mailto:info@snyderequipment.com)  
[www.snyderequipment.com](http://www.snyderequipment.com)

# COLOR SELECTION

## STANDARD LAMINATE FINISHES



## STANDARD METAL FINISH COLORS



## EDGE FINISHES

### VINYL COLOR MOLDINGS



- Black
- Brown
- Gray
- Putty
- Blue
- Yellow

### PREMIUM TOP OPTIONS



Perma-Tuff Edging

## PREMIUM LAMINATE FINISHES

(Available at additional cost)

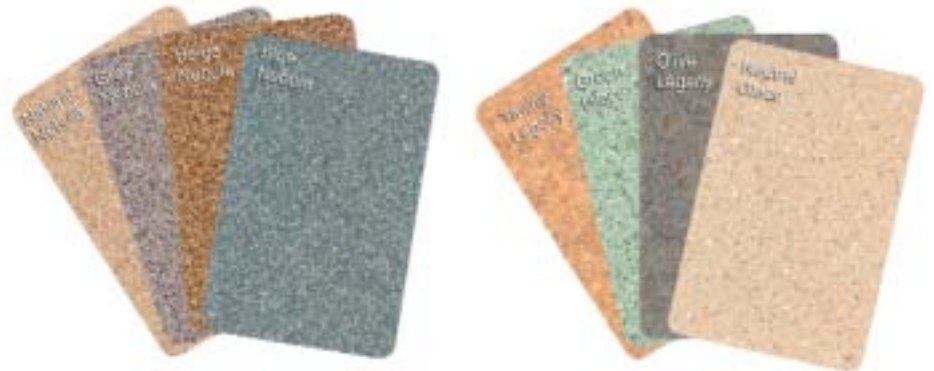

(Additional laminate selections are available upon request)

# WARRANTY

EF, Designer Series Folding Tables	10 years
Stages and Risers	10 years
LW Series Folding Tables	5 years
Mobile Utility Tables	5 years
Heavy-Duty Table Caddies	5 years
FN, F, TL, TLA, FA Series Folding Tables	1 year
Activity Tables	1 year
Folding Benches	1 year
Standard Table and Stage Caddies	1 year
Folding Chair Caddies	1 year

Midwest warrants products purchased hereunder to be free of defects in materials and workmanship, from the date of shipment for the period of time as follows:

This warranty shall not apply in the event products are damaged as a result of misuse, abuse, neglect, accident, improper application, modification or repair by persons not authorized by Midwest, where the products are damaged during shipment, or where the date stamps on the product have been defaced, modified or removed, unless considered unenforceable or unlawful under applicable law. All implied warranties including, but not limited to, warranties of merchantability and fitness for a particular purpose are hereby excluded. Purchaser's remedy, if any, for any defective products shall be limited to a refund, replacement or adjustment by Midwest of the products at Midwest's option and shall, in no event, include damages of any kind, whether incidental, consequential or otherwise.



The plywood frame is literally the backbone of this time tested folding table design. Attractive high-pressure laminate, bonded to a sheet of tempered hardboard, provides a durable surface for many years of demanding use. Pedestal style legs feature a 1.05" diameter, 14 gauge steel tube base to support heavy loads without bending.

## The **midwest** Advantage

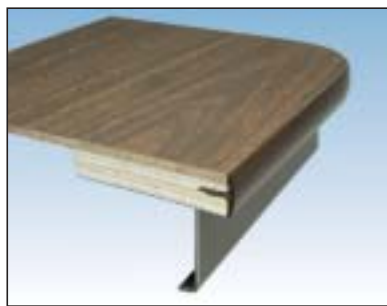

A plywood frame supported by a 16 gauge steel channel frame resists impact damage and carries heavy loads with ease.



Extra thick, 14 gauge steel leg base stands up to heavy use without bending. Non-removable, high impact plastic leg glides protect floors.



Leg braces incorporate spring loaded, case hardened steel detents for long life and fast set-up & tear-down.



Tops are reinforced against breakage with a square corner steel frame.

### FN SERIES FOLDING TABLES

TABLE STYLE	MODEL No	SIZE W x L x H	WT LBS
RECTANGULAR 	305FN	30" x 60" x 29"	55
	306FN	30" x 72" x 29"	59
	308FN	30" x 96" x 29"	73
	366FN	36" x 72" x 29"	71
	368FN	36" x 96" x 29"	83

10  
YEAR  
WARRANTY



CP618EF



630EF



R60EF

# The **midwest** Advantage

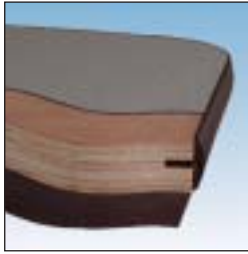

Solid 3/4" thick plywood is surfaced with high pressure plastic laminate, sealed with a backing sheet and edged with thick vinyl molding.



Tops are reinforced against breakage with a square corner steel frame.



Leg braces incorporate spring loaded, case hardened steel detents for long life and fast set-up & tear-down.



Extra thick, 14 gauge steel leg construction stands up to heavy use without bending. Non-removable, high impact plastic leg glides protect floors.

## SPECIFICATIONS

**TOPS** - EF Series Tops are constructed of solid, 3/4" thick, AC grade, exterior glue plywood, surfaced with high pressure plastic laminate and backed with a phenolic sheet to prevent moisture penetration. Tops are edged with 3/8" thick, vinyl T-molding, secured with staples from the underside of the table top at regular intervals.

**TOP SUPPORT STRUCTURE** - Table tops are supported by a formed steel channel frame of 1 1/4" deep 16 gauge steel. Frames are secured to the table top with screws placed no greater than 10" apart.

**LEG ASSEMBLIES** - Leg assemblies are wishbone style, constructed with one-piece load bearing vertical members of 1.05" diameter, 14 gauge steel tubing. Each leg is capped with high impact plastic glides, secured with internal spring steel grippers. Tables less than 48" in length or diameter are furnished with independent folding legs of 1.05" diameter, 14 gauge steel tubing. *Comfort Leg* assemblies are constructed of 1 1/4" diameter steel tubing.

**LEG BRACE MECHANISMS** - Folding leg braces are constructed of 3/8" wide, 1/8" thick edge radiused steel. Coil-spring actuated, case-hardened steel detents engage mating holes in the brace to secure the brace automatically when it is opened. Leg braces are attached to leg assemblies and pivot bracket by the use of steel shoulder rivets.

**METAL FINISH** - All metal parts are thoroughly cleaned and phosphatized to enhance paint adhesion. Metal parts are then finished with a thermofused epoxy powder coating.

### PREMIUM TOP OPTIONS



Aluminum Edge Molding

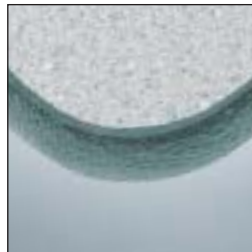

Perma-Tuff Edging  
(with high pressure laminate backing)







Comfort Leg Seminar Table



Standard Leg Seminar Table

### EF SERIES FOLDING TABLES

TABLE STYLE	MODEL No	SIZE W x L x H	Wt LBS
 RECTANGULAR	430EF	30" x 48" x 30"	47
	530EF	30" x 60" x 30"	55
	630EF	30" x 72" x 30"	62
	830EF	30" x 96" x 30"	77
	636EF	36" x 72" x 30"	76
	836EF	36" x 96" x 30"	86
 ROUND	R30EF	30" dia. x 30"	29
	R36EF	36" dia. x 30"	33
	R42EF	42" dia. x 30"	44
	R48EF	48" dia. x 30"	55
	R54EF	54" dia. x 30"	66
	R60EF	60" dia. x 30"	78
	R66EF**	66" dia. x 30"	81
R72EF**	72" dia. x 30"	87	
 GAME	SQ30EF	30" x 30" x 30"	36
	SQ36EF	36" x 36" x 30"	41
 STANDARD SEMINAR	518EF	18" x 60" x 30"	47
	618EF	18" x 72" x 30"	48
	818EF	18" x 96" x 30"	61
	524EF	24" x 60" x 30"	53
	624EF	24" x 72" x 30"	60
	824EF	24" x 96" x 30"	66
 COMFORT LEG SEMINAR	CP518EF*	18" x 60" x 29"	49
	CP618EF*	18" x 72" x 29"	50
	CP818EF*	18" x 96" x 29"	63
	CP524EF*	24" x 60" x 29"	57
	CP624EF*	24" x 72" x 29"	63
	CP824EF*	24" x 96" x 29"	70

\*30" height available upon request.

\*\*The laminate surface on these models is made from two pieces of plastic. A seam will be visible with all top colors, however, wood grain patterns help make seams less visible.

LW SERIES, lightweight folding tables are precision molded from durable, ABS plastic. Extra thick, extruded ABS bumper molding protects the edges against damage. Tables feature solid plastic, internal reinforced corners and spring-bolt actuated leg brace mechanisms. Standard models are furnished with wishbone style legs and are available in three standard plastic colors.

Specialty models are available in red, green, yellow and blue tops. Adjustable legs, that feature easy 1" height adjustment without the use of tools, are also available.



# The **midwest** Advantage

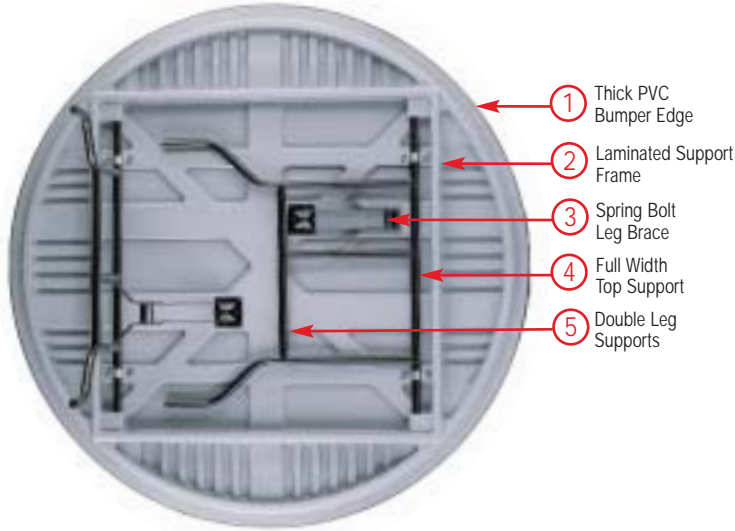

- ① Thick PVC Bumper Edge
- ② Laminated Support Frame
- ③ Spring Bolt Leg Brace
- ④ Full Width Top Support
- ⑤ Double Leg Supports

## SPECIFICATIONS

**TOPS** - Tops are constructed with two thermoformed sheets of heavy gauge ABS plastic molded to encase a structural frame of laminated wood. Impact absorbing reinforcements of injection molded ABS plastic provide protection to the corners of rectangular tabletops. High impact, ABS bumper molding shields the edges of the tabletop.

**LEG ASSEMBLIES** - Leg assemblies are wishbone style, constructed with one-piece load bearing vertical members of 1" diameter, 16 gauge steel tubing. Legs are capped with high impact plastic glides, secured with internal spring steel grippers. Tables less than 48" in length or diameter are furnished with independent folding legs of 1.05" diameter, 14 gauge steel tubing.

**LEG BRACE MECHANISMS** - Folding leg braces are constructed of 7/8" wide, 1/8" thick edge radiused steel. Coil-spring actuated, case-hardened steel detents engage mating holes in the brace to secure the brace automatically when it is opened. Leg braces are attached to leg assemblies and pivot bracket by the use of steel shoulder rivets. Pivot brackets are anchored to the table tops with screws and flathead bolts and locking nuts.

**METAL FINISH** - All metal parts are thoroughly cleaned and phosphatized to enhance paint adhesion. Metal parts are then finished with a thermofused epoxy powder coating.

## LW SERIES FOLDING TABLES

TABLE STYLE	MODEL No	SIZE W x L x H	Wt LBS
BANQUET 	530LW	30" x 60" x 30"	37
	630LW	30" x 72" x 30"	42
	830LW	30" x 96" x 30"	52
	636LW	36" x 72" x 30"	51
	836LW	36" x 96" x 30"	61
ROUND 	R30LW	30" dia. x 30"	26
	R48LW	48" dia. x 30"	45
	R60LW	60" dia. x 30"	58
	R66LW	66" dia. x 30"	67
	R72LW	72" dia. x 30"	81
1/2 ROUND 	HR30LW	1/2 of 30" dia. x 30"	24
	HR48LW	1/2 of 48" dia. x 30"	34
	HR60LW	1/2 of 60" dia. x 30"	44
	HR72LW	1/2 of 72" dia. x 30"	52
	HR96LW	1/2 of 96" dia. x 30"	84
1/4 ROUND 	QR48LW	1/4 of 48" dia. x 30"	21
	QR60LW	1/4 of 60" dia. x 30"	27
	QR72LW	1/4 of 72" dia. x 30"	32
	QR96LW	1/4 of 96" dia. x 30"	43
SQUARE 	SQ30LW	30" x 30" x 29"	28
	SQ36LW	36" x 36" x 29"	32
SERPENTINE 	S305LW	W" x A"/B x H" 30" x 30"/60" x 30"	55
STANDARD SEMINAR 	618LW	18" x 72" x 30"	31
	818LW	18" x 96" x 30"	37
	624LW	24" x 72" x 30"	36
	824LW	24" x 96" x 30"	44
COMFORT LEG SEMINAR 	CP618LW*	18" x 72" x 29"	33
	CP818LW*	18" x 96" x 29"	39
	CP624LW*	24" x 72" x 29"	38
	CP824LW*	24" x 96" x 29"	46

These models are available with gray, beige and brown tops only.

\*30" height available upon request.  
Some table styles such as serpentine, 1/4" round, and 1/2" round manufactured with solid plywood core tops, surfaced with ABS plastic and edged with vinyl molding.

## LW SPECIALTY MODELS

ADJUSTABLE HEIGHT	530LWA	30" x 60" x 22"-29"	38
	630LWA	30" x 72" x 22"-29"	43
	830LWA	30" x 96" x 22"-29"	53
ADJUSTABLE JR. HEIGHT	530LWJ	30" x 60" x 18"-25"	37
	630LWJ	30" x 72" x 18"-25"	42
	830LWJ	30" x 96" x 18"-25"	52
FIXED HEIGHT Wishbone leg	530LW	30" x 60" x 30"	37
	630LW	30" x 72" x 30"	42
	830LW	30" x 96" x 30"	52

These models are available with red, green, blue, yellow, gray, beige and brown tops.



Lightweight  
Easy to carry



Comfort Leg  
Seminar Table



Standard Leg  
Seminar Table



Leg braces incorporate spring loaded, case hardened steel detents for long life and fast set-up & tear-down.



1" diameter 16 gauge steel legs are capped with non-removable, high impact plastic glides.



Wishbone style legs feature one-piece floor to table top support and double cross bracing for maximum strength.

## METAL FINISH & EDGE MOLDING COLORS



## ABS PLASTIC COLORS





F SERIES FOLDING TABLES

TABLE STYLE	MODEL No	SIZE W x L x H	Wt LBS
SEMINAR 	518F	18" x 60" x 29"	48
	618F	18" x 72" x 29"	52
	818F	18" x 96" x 29"	63
	524F	24" x 60" x 29"	55
	624F	24" x 72" x 29"	62
	824F	24" x 96" x 29"	79
RECTANGULAR 	3060F*	30" x 60" x 29"	62
	3072F*	30" x 72" x 29"	72
	3096F*	30" x 96" x 29"	90
	3672F*	36" x 72" x 29"	82
	3696F*	36" x 96" x 29"	104
36" HEIGHT 	3072F36	30" x 72" x 36"	74
	3096F36	30" x 96" x 36"	92
	3672F36	36" x 72" x 36"	84
	3696F36	36" x 96" x 36"	106
ROUND 	R48F	48" dia. x 29"	63
	R60F	60" dia. x 29"	91
	R72F**	72" dia. x 29"	145
SQUARE 	SQ30F	30" x 30" x 29"	35
	SQ36F	36" x 36" x 29"	40

\*Furnished with pedestal style legs.

\*\*The laminate surface on these models is made from two pieces of plastic. A seam will be visible with all top colors, however, wood grain patterns help make seams less visible.

# The **midwest** Advantage



Extra thick, 14 gauge steel leg construction stands up to heavy use without bending. Non-removable, high impact plastic leg glides protect floors.



Leg braces incorporate spring loaded, case hardened steel detents for long life and fast set-up & tear-down.



Tops are reinforced against breakage with a square corner steel frame.

## SPECIFICATIONS

**TOPS** - F Series Tops are constructed of solid, 3/8" thick, 47lb industrial grade, particleboard, surfaced with high pressure plastic laminate and backed with a phenolic sheet to prevent moisture penetration. Tops are edged with vinyl T-molding, secured with staples from the underside of the table top at regular intervals.

**TOP SUPPORT STRUCTURE** - Table tops are supported by a formed steel channel frame of 1-1/8" deep 16 gauge steel. Frames are secured to the table top with screws placed no greater than 10" apart.

**LEG ASSEMBLIES** - Wishbone leg assemblies are constructed with one-piece load bearing members of 1.05" diameter, 14 gauge steel tubing. Pedestal style legs are constructed with base sections of 1.05" diameter, 14 gauge tubing and all other components being of 1" diameter, 16 gauge tubing. Legs are capped with high impact plastic glides, secured with internal spring steel grippers. Tables less than 48" in length or diameter are furnished with independent folding legs of 1.05" diameter, 14 gauge steel tubing.

**LEG BRACE MECHANISMS** - Folding leg braces are constructed of 3/8" wide, 3/8" thick edge radiused steel. Coil-spring actuated, case-hardened steel detents engage mating holes in the brace to secure the brace automatically when it is opened. Leg braces are attached to leg assemblies and pivot bracket by the use of steel shoulder rivets.

**METAL FINISH** - All metal parts are thoroughly cleaned and phosphatized to enhance paint adhesion. Metal parts are then finished with a thermofused epoxy powder coating.

## Cafeteria Seating

## FOLDING BENCHES

Folding benches offer an economical solution for your cafeteria seating needs. Benches may be folded quickly for compact storage. The sturdy frame and heavy-duty leg design provides safe seating for adults. A durable high-pressure laminate surface stands up to many years of frequent cleaning and constant use.



Model No: B6F Size: 12"W x 72"L x 18"H Wt: 37 lbs  
 Model No: B8F Size: 12"W x 96"L x 18"H Wt: 50 lbs



TLA245



TLA245



TLA48R



TL306

TLA SERIES - HEIGHT ADJUSTMENT



Vertical adjustment is accomplished quickly by pulling out on the spring loaded locking pin.

TL SERIES PLYWOOD CORE Fixed Height Models

TABLE STYLE	MODEL No	SIZE W x L x H	Wt LBS
SEMINAR	TL186EF	18" x 72" x 29"	57
	TL188EF	18" x 96" x 29"	67
	TL246EF	24" x 72" x 29"	68
	TL248EF	24" x 96" x 29"	78
	TL305EF*	30" x 60" x 29"	67
CONFERENCE UTILITY	TL306EF	30" x 72" x 29"	76
	TL308EF	30" x 96" x 29"	91
	TL366EF	36" x 72" x 29"	84
	TL368EF	36" x 96" x 29"	91

TL SERIES PARTICLEBOARD CORE Fixed Height Models

TABLE STYLE	MODEL No	SIZE W x L x H	Wt LBS
SEMINAR	TL185*	18" x 60" x 29"	58
	TL186	18" x 72" x 29"	62
	TL188	18" x 96" x 29"	73
	TL244*	24" x 48" x 29"	67
	TL245*	24" x 60" x 29"	71
	TL246	24" x 72" x 29"	74
	TL248	24" x 96" x 29"	87
CONFERENCE UTILITY	TL305*	30" x 60" x 29"	74
	TL306	30" x 72" x 29"	84
	TL308	30" x 96" x 29"	101
	TL366	36" x 72" x 29"	94
	TL368	36" x 96" x 29"	114

\*Tables will not fold flat for stacking.

TLA SERIES PLYWOOD CORE

Adjustable Height Models

TABLE STYLE	MODEL No	SIZE W x L	TABLE HEIGHT OPTIONS			Wt LBS
			STANDARD	TLA-1	TLA-2	
SEMINAR	TLA186EF	18" x 72"	22"-29"	19"-26"	27"-34"	57
	TLA188EF	18" x 96"	22"-29"	19"-26"	27"-34"	67
	TLA245EF	24" x 60"	22"-26"	19"-26"	27"-34"	71
	TLA246EF	24" x 72"	22"-26"	19"-26"	27"-34"	68
	TLA248EF	24" x 96"	22"-29"	19"-26"	27"-34"	78
CONFERENCE UTILITY	TLA305EF	30" x 60"	22"-29"	19"-26"	27"-34"	67
	TLA306EF	30" x 72"	22"-29"	19"-26"	27"-34"	76
	TLA308EF	30" x 96"	22"-29"	19"-26"	27"-34"	91
	TLA366EF	36" x 72"	22"-29"	19"-26"	27"-34"	84
	TLA368EF	36" x 96"	22"-29"	19"-26"	27"-34"	91
ROUND	TLA48REF	48" dia.	22"-29"	19"-26"	27"-34"	60

TLA SERIES PARTICLEBOARD CORE

Adjustable Height Models

TABLE STYLE	MODEL No	SIZE W x L	TABLE HEIGHT OPTIONS			Wt LBS
			STANDARD	TLA-1	TLA-2	
SEMINAR	TLA186	18" x 72"	22"-29"	19"-26"	27"-34"	62
	TLA188	18" x 96"	22"-29"	19"-26"	27"-34"	73
	TLA244	24" x 48"	22"-29"	19"-26"	27"-34"	67
	TLA245	24" x 60"	22"-26"	19"-26"	27"-34"	71
	TLA246	24" x 72"	22"-26"	19"-26"	27"-34"	74
	TLA248	24" x 96"	22"-29"	19"-26"	27"-34"	87
CONFERENCE UTILITY	TLA305	30" x 60"	22"-29"	19"-26"	27"-34"	76
	TLA306	30" x 72"	22"-29"	19"-26"	27"-34"	84
	TLA308	30" x 96"	22"-29"	19"-26"	27"-34"	101
	TLA366	36" x 72"	22"-29"	19"-26"	27"-34"	94
	TLA368	36" x 96"	22"-29"	19"-26"	27"-34"	114
ROUND	TLA48R	48" dia.	22"-29"	19"-26"	27"-34"	68

If other than standard height is desired, height options TLA-1 or TLA-2 must be specified.

Comfort Leg tables for classroom, seminar and training facilities offer unobstructed knee space not available with other folding tables. Tables quickly fold for compact storage when required, yet are incredibly stable when opened for use. Conference/utility models look good enough for the boardroom, but their plywood core tops provide the durability to withstand many years of rough use.



CP618EF



CP518EF



DS630EF

PLYWOOD CORE TOP

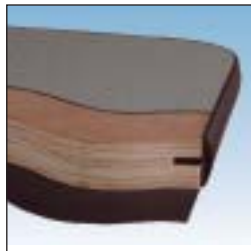

Solid 3/4" thick plywood is surfaced with high pressure plastic laminate, sealed with a backing sheet and edged with vinyl molding.

PREMIUM TOP OPTIONS



Aluminum Edge Molding





Perma-Tuff Edging

METAL FINISH COLORS



DESIGNER SERIES

TABLE STYLE	POWDERCOAT LEG FINISH	CHROME LEG FINISH	SIZE W x L x H	WT LBS
 <p>COMFORT LEG SEMINAR</p>	CP518EF	CS518EF	18" x 60" x 29"	49
	CP618EF	CS618EF	18" x 72" x 29"	50
	CP818EF	CS818EF	18" x 96" x 29"	63
	CP524EF	CS524EF	24" x 60" x 29"	57
	CP624EF	CS624EF	24" x 72" x 29"	63
	CP824EF	CS824EF	24" x 96" x 29"	70
	 <p>CONFERENCE UTILITY</p>	DP530EF*	DS530EF*	30" x 60" x 29"
DP630EF		DS630EF	30" x 72" x 29"	59
DP830EF		DS830EF	30" x 96" x 29"	73
DP636EF		DS636EF	36" x 72" x 29"	73
DP836EF		DS836EF	36" x 96" x 29"	82
 <p>MODESTY PANELS</p>		MP510		10" x 60"
	MP610		10" x 72"	10
	MP810		10" x 92"	13

30" height available upon request.

\*Legs do not fold flat for stacking. Store on model TEC caddy. Modesty panels available only on 18" and 24" models.



A self-locking screw draws the leg insert tightly against the leg housing for a rigid connection. Leg inserts are chrome plated for durability and are adjustable in 1" increments



Formed steel I beams are furnished on all tables 60" and longer to prevent sagging.



Assembly is fast and easy. Simply slide the leg into the factory equipped mounting bracket and insert one screw to lock the leg in place.



Vinyl Bullnose edge



Optional PermaTuff polyurethane epoxy edge

PARTICLEBOARD CORE ACTIVITY TABLES

TABLE STYLE	SIZE W x L x H	Wt LBS	ADJ. HEIGHT CHROME LEG INSERTS MODEL No	29" FIXED HT POWDERCOATED LEGS MODEL No
Rectangular	24" x 36" x 22-29"	41	AA324F	AF324F
	24" x 48" x 22-29"	54	AA424F	AF424F
	24" x 60" x 22-29"	66	AA524F	AF524F
	24" x 72" x 22-29"	74	AA624F	AF624F
	30" x 48" x 22-29"	60	AA430F	AF430F
	30" x 60" x 22-29"	76	AA530F	AF530F
	30" x 72" x 22-29"	88	AA630F	AF630F
	30" x 96" x 22-29"	106	AA830F	AF830F
	36" x 60" x 22-29"	89	AA536F	AF536F
	36" x 72" x 22-29"	105	AA636F	AF636F
42" x 60" x 22-29"	113	AA542F	AF542F	
Round	36" dia. x 22-29"	48	AAR36F	AFR36F
	42" dia. x 22-29"	59	AAR42F	AFR42F
	48" dia. x 22-29"	74	AAR48F	AFR48F
	60" dia. x 22-29"	109	AAR60F	AFR60F
Square	36" x 36" x 22-29"	56	AASQ36F	AFSQ36F
	42" x 42" x 22-29"	76	AASQ42F	AFSQ42F
	48" x 48" x 22-29"	99	AASQ48F	AFSQ48F
½ Round	½ of 48" dia. x 22-29"	42	AAHR48F	AFHR48F

PARTICLEBOARD CORE ACTIVITY TABLES

TABLE STYLE	SIZE W x L x H	Wt LBS	ADJ. HEIGHT CHROME LEG INSERTS MODEL No	29" FIXED HT POWDERCOATED LEGS MODEL No
Trapezoid	24" x 24" x 48" x 22-29"	37	AATP424F	AFTP424F
	30" x 30" x 60" x 22-29"	51	AATP530F	AFTP530F
Kidney	48" x 72" x 22-29"	110	AAKY648F	AFKY648F
	48" x 96" x 22-29"	156	AAKY848F	AFKY848F
Horseshoe	60" x 66" x 22-29"	124	AAHS666F	AFHS666F
Clover	48" dia. x 22-29"	68	AAC48F	AAFC48F
Flower	60" dia. x 22-29"	105	AAF60F	AFF60F

Lower height tables that adjust from 17" to 25" are available upon request. Black metal finish and edge molding are standard. Tops are constructed of solid 47 lb industrial grade particleboard core, edged with vinyl bullnose molding and are 1 ¼" thick.

## PLYWOOD CORE ACTIVITY TABLES

TABLE STYLE	SIZE W x L x H	WT LBS	ADJ. HEIGHT CHROME LEG INSERTS MODEL No	29" FIXED HT POWDERCOATED LEGS MODEL No
Rectangular	24" x 36" x 22-29"	30	AA324EF	AF324EF
	24" x 48" x 22-29"	39	AA424EF	AF424EF
	24" x 60" x 22-29"	49	AA524EF	AF524EF
	24" x 72" x 22-29"	55	AA624EF	AF624EF
	30" x 48" x 22-29"	60	AA430EF	AF430EF
	30" x 60" x 22-29"	45	AA530EF	AF530EF
	30" x 72" x 22-29"	55	AA630EF	AF630EF
	30" x 96" x 22-29"	66	AA830EF	AF830EF
	36" x 60" x 22-29"	67	AA536EF	AF536EF
	36" x 72" x 22-29"	77	AA636EF	AF636EF
42" x 60" x 22-29"	84	AA542EF	AF542EF	
Round	36" dia. x 22-29"	25	AAR36EF	AFR36EF
	42" dia. x 22-29"	41	AAR42EF	AFR42EF
	48" dia. x 22-29"	55	AAR48EF	AFR48EF
	60" dia. x 22-29"	81	AAR60F	AFR60EF
Square	36" x 36" x 22-29"	42	AASQ36EF	AFSQ36EF
	42" x 42" x 22-29"	58	AASQ42EF	AFSQ42EF
	48" x 48" x 22-29"	76	AASQ48EF	AFSQ48EF
1/2 Round	1/2 of 48" dia. x 22-29"	32	AAHR48EF	AFHR48EF

## PLYWOOD CORE ACTIVITY TABLES

TABLE STYLE	SIZE W x L x H	WT LBS	ADJ. HEIGHT CHROME LEG INSERTS MODEL No	29" FIXED HT POWDERCOATED LEGS MODEL No
Trapezoid	24" x 24" x 48" x 22-29"	27	AATP424EF	AFTP424EF
	30" x 30" x 60" x 22-29"	38	AATP530EF	AFTP530EF
Kidney	48" x 72" x 22-29"	89	AAKY648EF	AFKY648EF
	48" x 96" x 22-29"	119	AAKY848EF	AFKY848EF
Horseshoe	60" x 66" x 22-29"	95	AAHS666EF	AFHS666EF
Clover	48" dia. x 22-29"	51	AAC48EF	AAFC48EF
Flower	60" dia. x 22-29"	77	AAF60EF	AFF60EF

Lower height tables that adjust from 17" to 25" are available upon request. Black metal finish and edge molding are standard. Tops are constructed of solid 47 lb industrial grade particleboard core, edged with vinyl bullnose molding and are 1 1/8" thick.

# Adjustable Pedestal Leg

# ACTIVITY TABLES



Legs are adjustable in one inch increments.



AP630



AP424F



Support beam is in contact with the underside of the table to prevent sagging.

## ADJ. PEDESTAL LEG TABLES Particle Board Top

TABLE STYLE	MODEL No	SIZE W x L x H	WT LBS
Rectangular	AP324F	24" x 36" x 23-30"	52
	AP424F	24" x 48" x 23-30"	66
	AP524F	24" x 60" x 23-30"	79
	AP624F	24" x 72" x 23-30"	88
	AP430F	30" x 48" x 23-30"	72
	AP530F	30" x 60" x 23-30"	89
	AP630F	30" x 72" x 23-30"	102
	AP536F	36" x 60" x 23-30"	102
	AP636F	36" x 72" x 23-30"	119
	AP542F	42" x 60" x 23-30"	126
Trapezoid	APHR530F	30" x 30" x 60" x 23"-30"	64
1/2 Round	APHR60F	60" dia. x 30" x 23"-30"	55
Round	APR48F	48" dia. x 29"	85

## ADJ. PEDESTAL LEG TABLES Plywood Top

TABLE STYLE	MODEL No	SIZE W x L x H	WT LBS
Rectangular	AP324EF	24" x 36" x 23-30"	41
	AP424EF	24" x 48" x 23-30"	50
	AP524EF	24" x 60" x 23-30"	60
	AP624EF	24" x 72" x 23-30"	66
	AP430EF	30" x 48" x 23-30"	56
	AP530EF	30" x 60" x 23-30"	66
	AP630EF	30" x 72" x 23-30"	77
	AP536EF	36" x 60" x 23-30"	78
	AP636EF	36" x 72" x 23-30"	88
	AP542EF	42" x 60" x 23-30"	95
Trapezoid	APHR530EF	30" x 30" x 60" x 23"-30"	49
1/2 Round	APHR60EF	60" dia. x 30" x 23"-30"	43
Round	APR48EF	48" dia. x 29"	66

All models are adjustable except round models which are furnished with a fixed height center pedestal and powdercoat finish.



Cafe tables feature easy to assemble, sturdy, cast iron bases that may be matched with the top of your choice. Tops are available in a wide range of attractive, yet durable, high-pressure plastic laminates. Choose the top that suits your environment and budget; economical particleboard core tops with vinyl edge molding or solid plywood core tops with *PermaTuff*, epoxy urethane edge treatment for maximum durability.



CAFE TABLE BASES

MODEL No	SIZE W x L x H	WT LBS
CBR1730	17" dia. x 28"	29
CBR1742	17" dia. x 41"	30
CBR2230	22" dia. x 28"	40
CBR2242	22" dia. x 41"	41
CBR3330	33" dia. x 28"	71
CB2230	22" x 22" x 28"	20
CB3030	30" x 30" x 28"	23
CB52230	5" x 22" x 28"	14
CB52242	5" x 22" x 41"	15
CBLE	Auto 2 1/2" leveling guides	

Available in black finish only. Bases are furnished with manual leveling glides.

BASE SELECTION CHART

Available in 28" and 41" heights

TOP SIZE	4 POINT BASE No	ROUND BASE No	BI-POINT BASE No
24" x 24"	CB2230	CBR1730 CBR1742	
24" x 30"	CB2230	CBR1730 CBR1742	
24" X 72"			CB52230 CB52242
24" X 96"			CB52230 CB52242
30" x 30"	CB2230	CBR1730 CBR1742	
30" x 42"	CB3030	CBR2230 CBR2242	
30" x 48"	CB3030	CBR2230 CBR2242	
36" x 36"	CB3030	CBR3030 CBR2242	
42" x 42"	CB3030	CBR3030 CBR3042	
24" dia.	CB2230	CBR1730 CBR1742	
30" dia.	CB2230	CBR1730 CBR1742	
36" dia.	CB3030	CBR2230 CBR2242	
42" dia.	CB3030	CBR3030	
48" dia.		CBR3030	



CAFE TABLE TOPS

MODEL No	SIZE W x L x H	WT LBS	MODEL No	SIZE W x L x H	WT LBS
<b>Particleboard core, vinyl edge Laminate surface, 1-3/16" thick</b>			<b>Plywood Core, PermaTuff™ edge Laminate Surface, 1-1/16" thick</b>		
T2424F	24" x 24"	21	T2424EFP	24" x 24"	14
T2430F	24" x 30"	28	T2430EFP	24" x 30"	18
T2472F	24" x 72"	75	T2472EFP	24" x 72"	53
T2496F	24" x 96"	102	T2496EFP	24" x 96"	72
T3030F	30" x 30"	36	T3030EFP	30" x 30"	25
T3042F	30" x 42"	53	T3042EFP	30" x 42"	37
T3048F	30" x 48"	62	T3048EFP	30" x 38"	43
T3636F	36" x 36"	55	T3636EFP	36" x 36"	38
T4242F	42" x 42"	77	T4242EFP	42" x 42"	54
TR24F	24" dia.	21	TR24EFP	24" dia.	14
TR30F	30" dia.	36	TR30EFP	30" dia.	25
TR36F	36" dia.	55	TR36EFP	36" dia.	38
TR42F	42" dia.	77	TR42EFP	42" dia.	54
TR48F	48" dia.	102	TR48EFP	48" dia.	72

Standard edge color is black.



2306FA

The right height for each activity is at your fingertips with Midwest snap-lock, adjustable folding leg, activity tables. Independent leg adjustability is made possible by snap locks that adjust on one-inch centers without the use of tools (no screws). Simply press the snap button to release the lock and slide the leg insert to the desired position.



K2306FA  
(Junior Ht.)

### FA SERIES - HEIGHT ADJUSTMENT



Leg braces incorporate spring loaded, case hardened steel detents for long life and fast set-up & tear-down.

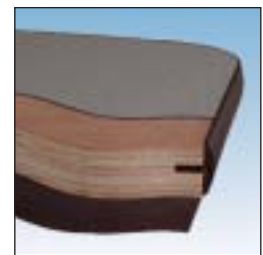

Optional solid 3/4" thick plywood is surfaced with high pressure plastic laminate, sealed with a backing sheet and edged with thick vinyl molding.



To adjust, simply press the snaplock button and slide the leg insert to the desired position.

### FA SERIES

TABLE STYLE	MODEL No	SIZE W x L	TABLE HT OPTIONS		WT LBS
			STANDARD	JUNIOR	
SEMINAR [ ]	2185FA	18" x 60"	22"-29"	18"-25"	48
	2186FA	18" x 72"	22"-29"	18"-25"	52
	2188FA	18" x 96"	22"-29"	18"-25"	63
	2245FA	24" x 60"	22"-29"	18"-25"	55
	2246FA	24" x 72"	22"-29"	18"-25"	62
	2248FA	24" x 96"	22"-29"	18"-25"	79
UTILITY [ ]	2305FA	30" x 60"	22"-29"	18"-25"	62
	2306FA	30" x 72"	22"-29"	18"-25"	72
	2308FA	30" x 96"	22"-29"	18"-25"	90
	2366FA	36" x 72"	22"-29"	18"-25"	82
	2368FA	36" x 96"	22"-29"	18"-25"	104
PLYWOOD TOP [ ]	2305EFA	30" x 60"	22"-29"	18"-25"	50
	2306EFA	30" x 72"	22"-29"	18"-25"	56
	2308EFA	30" x 96"	22"-29"	18"-25"	70
<b>JUNIOR HEIGHT</b>					
RECTANGLE	K2305FA	30" x 60"	22"-29"	18"-25"	58
	K2306FA	30" x 72"	22"-29"	18"-25"	68
	K2308FA	30" x 96"	22"-29"	18"-25"	86
RECTANGLE <i>plywood top</i>	K2305EFA	30" x 60"	22"-29"	18"-25"	46
	K2306EFA	30" x 72"	22"-29"	18"-25"	56
	K2308EFA	30" x 96"	22"-29"	18"-25"	74

Black metal finish is standard on all activity tables.

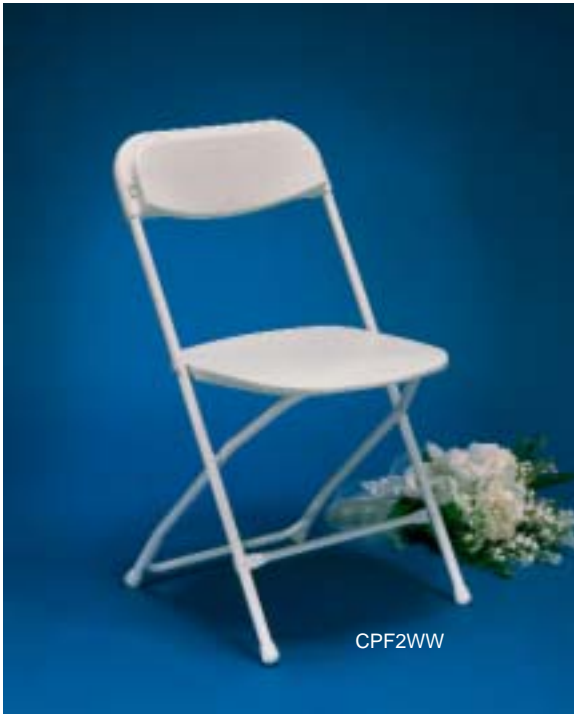

CPF2WW

Midwest's Folding chairs are specially designed for easy handling and compact storage. Their light weight makes it easy to carry a number of chairs at one time to reduce set up and tear down time. Designed to nest when stacked, as many as 68 chairs may be stored and moved on our convenient flat stacking caddy. Up to 120 chairs may be moved and stored on our two-tier caddy for optimum convenience.

Seats and backs are injection molded of resilient, high-impact polypropylene plastic that is easy to clean and durable enough to withstand many years of tough use. Our chip resistant, powdercoated enamel finish protects the frame and makes cleaning easy.



CPF2MC



PLASTIC SEAT & BACK COLORS

DINING PITCH - STANDARD  
(auditorium pitch - available)

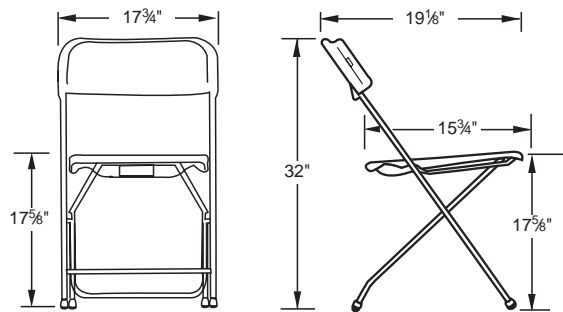

METAL FRAME COLORS



CHAIR STYLE	MODEL No	FRAME COLOR	SEAT BACK COLOR	WT
	CPF2MS	Medium Gray	Slate Blue	6.8
	CPF2MC	Medium Gray	Royal Blue	6.8
	CPF2MR	Medium Gray	Burgundy	6.8
	CPF2MG	Medium Gray	Charcoal	6.8
	CPF2MB	Medium Gray	Black	6.8
	CPF2BB	Black	Black	6.8
	CPF2NN	Neutral	Neutral	6.8
	CPF2NH	Neutral	Chocolate Brown	6.8
	CPF2WW	White	Bright White	6.8
	<i>All stock models are dining pitch. Auditorium pitch available upon request.</i>			
	ACG ARG ARS ARB	Ganger Clip Replacement Glide Replacement Seat Replacement Back		

# FOLDING CHAIR CADDIES

## TWO TIER CADDY



## SINGLE LEVEL CADDY



**Model No:** CC60  
**Size:** 64"L x 21"W x 38½"H (28-30 cap)  
**Weight:** 53 lbs

**Model No:** CC72  
**Size:** 76"L x 21"W x 38½"H (34-36 cap)  
**Weight:** 57 lbs

**Model No:** CC84  
**Size:** 88"L x 21"W x 38½"H (40-42 cap)  
**Weight:** 66 lbs

**Model No:** CC96  
**Size:** 100"L x 21"W x 38½"H (46-48 cap)  
**Weight:** 70 lbs

### OPTIONAL ADJUSTABLE CHAIR SUPPORT

**Model No:** ACH - For single level caddies  
 ACHU - For understage caddies  
**Weight:** 7 lbs

For understage caddies with 22" high handles, add letter U (i.e. CCU60)

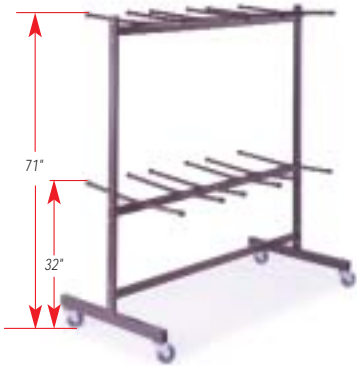

**Model No:** VCT72  
**Size:** 66"L x 32"W x 71"H (84-120 capacity)  
**Weight:** 95 lbs



### POLY CHAIR CADDY

**Model No:** CCP  
**Size:** 42"L x 20"W x 38"H (68 cap)  
**Weight:** 39 lbs



Chair supports adjust horizontally preventing chairs from falling over as they are transported.

# MOBILE UTILITY TABLES



MB306EF



Folds for compact storage



MU306EF

### MOBILE UTILITY TABLE WITH RISER SHELF

<b>Model No:</b> MB306EF	<b>MB308EF</b>
<b>Size:</b> 30"W x 72"L x 30"H	30"W x 96"L x 30"H
<b>Weight:</b> 108 lbs	130 lbs
Riser shelf included	

### INDIVIDUAL RISER SHELF

<b>Model No:</b> SB126EF	<b>SB128EF</b>
<b>Size:</b> 12"W x 72"L x 12"H	12"W x 96"L x 12"H
<b>Weight:</b> 22 lbs	35 lbs

Riser shelf may also be used with most folding tables.

Mobile Utility Tables facilitate the display and movement of equipment, supplies, instructional materials, exhibits and classroom demonstrations throughout your facility. Ideal for use in the classroom, cafeteria, media center, gymnasium and office, mobile utility tables eliminate the need for your staff to hand-carry heavy tables. Plastic laminate tops with plywood core construction and heavy-duty steel frames, assure long-term durability.

### MOBILE UTILITY TABLE

<b>Model No:</b> MU306EF	<b>MU308EF</b>
<b>Size:</b> 30"W x 72"L x 30"H	30"W x 96"L x 30"H
<b>Weight:</b> 86 lbs	95 lbs

# HEAVY-DUTY TABLE CADDIES



HRTC

**Model No:** HRTC  
**Size:** 61"L x 31½"W x 42½"H  
**Weight:** 81 lbs  
**Capacity:** 8 (48"-72" round tables)

**HTEC**  
 61"L x 31½"W x 34½"H  
 75 lbs  
 8 (rectangular/serpentine tables)



HTC72

**Model No:** HTC72  
**Size:** 74"L x 31½"W x 41½"H  
**Weight:** 82 lbs  
**Capacity:** 10-12 (24"/30"/36" x 60"/72"L tables)  
 20-24 (18"W x 72"L tables)

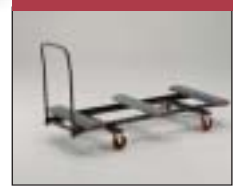

**HTC96**  
 97½"L x 31½"W x 41½"H  
 93 lbs  
 10-12 (24"/30"/36" x 96"L tables)  
 20-24 (18"W x 96"L tables)

# STANDARD TABLE CADDIES



RTCHB

**Model No:** RTCHB  
**Size:** 61"L x 31½"W x 41½"H  
**Weight:** 70 lbs  
**Capacity:** 8 (60"-72" round tables)



RTC

**Model No:** RTC  
**Size:** 49"L x 31½"W x 41½"H  
**Weight:** 65 lbs  
**Capacity:** 8 (48"-60" round tables)



TC72

**Model No:** TC72  
**Size:** 74"L x 31½"W x 36½"H  
**Weight:** 67 lbs  
**Capacity:** 10-12 (24"/30"/36" x 60"/72"L tables)  
 20-24 (18"W x 72"L tables)



**TC96**  
 97½" x 31½" x 36½"  
 78 lb  
 10-12 (24"/30"/36" x 96" tables)  
 20-24 (18"W x 96"L tables)



TEC

**Model No:** TEC  
**Size:** 49"L x 31½"W x 32½"H  
**Weight:** 64 lbs  
**Capacity:** 8 (rectangular/serpentine tables)

