

The logo for Snyder Equipment, Inc. features the word "SNYDER" in large, bold, white, sans-serif capital letters. This text is set against a solid blue rectangular background. Below the blue background is a horizontal yellow bar. To the left of the yellow bar is a solid yellow circle. To the right of the yellow bar, the words "Equipment, Inc." are written in a smaller, bold, blue, sans-serif font. Below "Equipment, Inc." is the tagline "Storing, Rolling, Lifting since 1947" in a smaller, blue, sans-serif font.

SNYDER

Equipment, Inc.

Storing, Rolling, Lifting since 1947

PRODUCT INFORMATION

DYNA STACKING RACKS

2946 Larimer St. Denver, CO 80205

303-295-1100 / 800-373-7693

FAX 303-295-2464

Email info@snyderequipment.com

www.snyderequipment.com

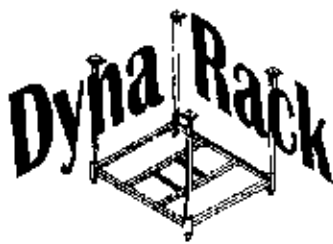

PORTABLE STACKING RACKS

- 2000 lb or 4000 lb capacities.
- Safe positive stacking up to 5 units high.
- Utilize vertical storage space. Use your valuable floor space for production.
- Portable for flexible in-plant storage.
- Cut handling time. Move more material with fewer moves.
- Rugged design prevents product damage.
- Side or end frames are available.

2000 LB. CAPACITY: (S)
 Corner posts: 1 1/2" square tubing
 Pockets: 1" square tubing

4000 LB. CAPACITY: (H)
 Corner posts: 2" square tubing
 Pockets: 2" square tubing

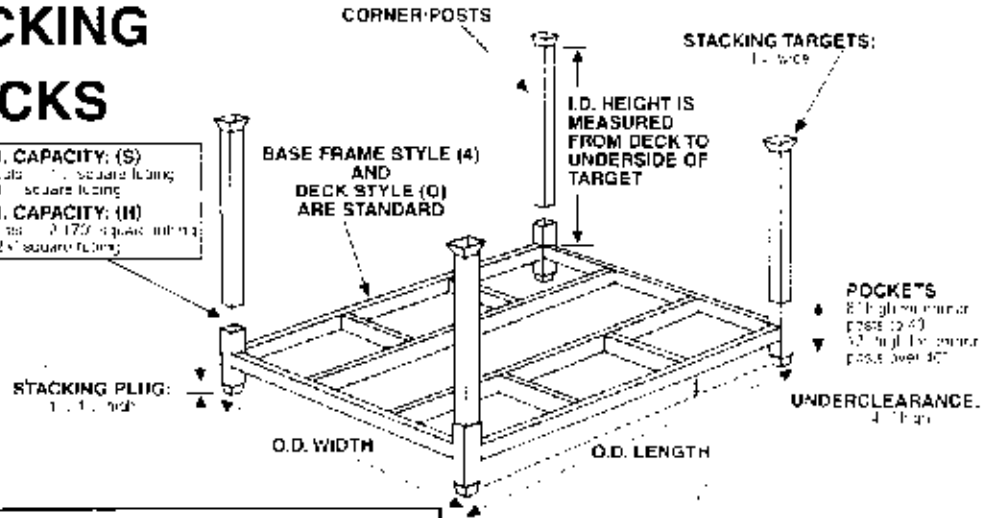

BASE FRAME Base Frame Style (4) and Deck Style (O).					CORNER POSTS Set of Four (4)						
Call for other base frame & deck styles											
Outside (O.D.) Dimension		2000 lb. Capacity		4000 lb. Capacity		Inside (I.D.) Dimension		2000 lb. Capacity		4000 lb. Capacity	
Width x Length	Model No.	Wt. (lbs)	Model No.	Wt. (lbs)	Height above Deck	Model No.	Wt. (lbs)	Model No.	Wt. (lbs)		
35" x 42"	S3642D2	44	H3F42D4	59	20"	P20D2	20	P20D4	31		
35" x 48"	S3648D2	50	H3C48D4	60	24"	P24D2	22	P24D4	35		
35" x 54"	S3654D2	56	H3E54D4	76	28"	P28D2	24	P28D4	39		
35" x 60"	S3660D2	62	H3E60D4	80	30"	P30D2	26	P30D4	41		
42" x 42"	S4242D2	55	H4242D4	74	34"	P34D2	29	P34D4	44		
42" x 48"	S4248D2	50	H4248D4	81	36"	P36D2	30	P36D4	47		
42" x 54"	S4254D2	65	H4254D4	86	40"	P40D2	32	P40D4	50		
42" x 60"	S4260D2	76	H4260D4	94	** 44"	P44D2	35	P44D4	55		
48" x 48"	S4848D2	66	H4548D4	92	** 48"	P48D2	37	P48D4	59		
48" x 54"	S4854D2	70	H4554D4	97	** 60"	P60D2	55	P60D4	69		
48" x 60"	S4860D2	82	H4560D4	102	** 72"	P72D2	73	P72D4	75		
60" x 60"	S5060D2	102	H6060D4	111							

Add \$5.00 for 6" x 8" 11 ga. square stacking targets

** Posts over 40" require 12" corner pockets

*** Posts 72" high require 15" pockets

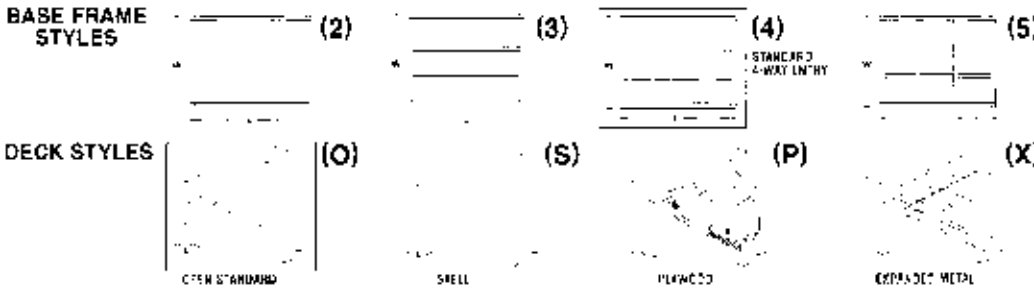
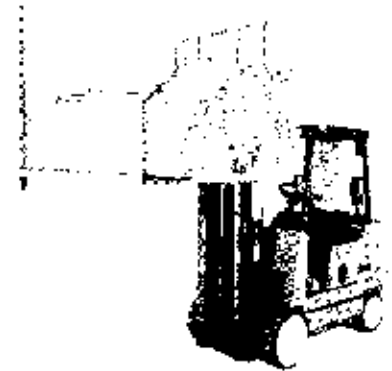

SIDE AND END FRAMES					
Width or Length	Height Above Deck	2000 lb. Capacity (Set of Two)		4000 lb. Capacity (Set of Two)	
		Model No.	Wt. (lbs)	Model No.	Wt. (lbs)
36"	24	SF3624D2	38	HF3624D4	59
	30	SF3630D2	42	HF3630D4	66
	** 36	SF3636D2	48	HF3636D4	74
	** 42	SF3642D2	52	HF3642D4	81
42"	** 48	SF3648D2	56	HF3648D4	89
	24	SF4224D2	42	HF4224D4	67
	30	SF4230D2	48	HF4230D4	75
	** 36	SF4236D2	54	HF4236D4	84
48"	** 42	SF4242D2	59	HF4242D4	95
	** 46	SF4246D2	61	HF4246D4	101
	24	SF4824D2	48	HF4824D4	71
	30	SF4830D2	48	HF4830D4	79
54"	** 36	SF4836D2	54	HF4836D4	89
	** 42	SF4842D2	59	HF4842D4	99
	** 46	SF4846D2	64	HF4846D4	105
	24	SF5424D2	46	HF5424D4	77
60"	30	SF5430D2	56	HF5430D4	87
	** 36	SF5436D2	62	HF5436D4	95
	** 42	SF5442D2	68	HF5442D4	105
	** 46	SF5446D2	72	HF5446D4	114
60"	24	SF6024D2	51	HF6024D4	81
	30	SF6030D2	56	HF6030D4	91
	36	SF6036D2	64	HF6036D4	100
	** 42	SF6042D2	70	HF6042D4	109
** 46	SF6046D2	75	HF6046D4	118	

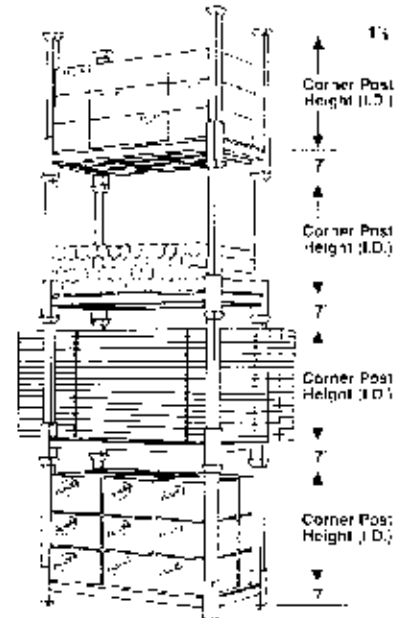
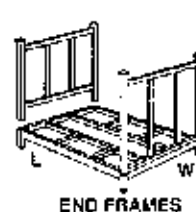
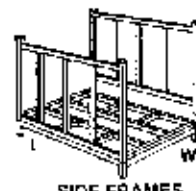

** Frames over 40" high require 12" pockets